



TO-251S/TO-252-2L Plastic-Encapsulate Regulators

CJ78M15 Three-terminal positive voltage regulator

FEATURES

- Maximum Output current I_{OM} : 0.5 A
- Output voltage V_O : 15V
- Continuous total dissipation
 P_D : 1.25 W ($T_a = 25^\circ\text{C}$)

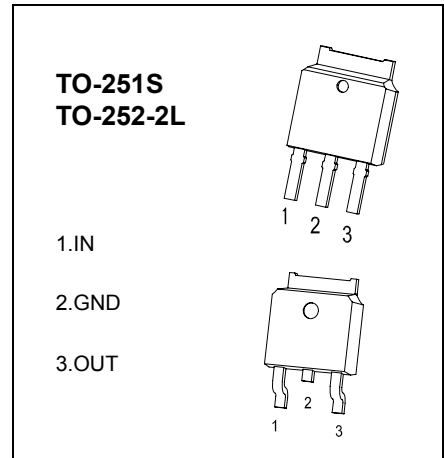

ABSOLUTE MAXIMUM RATINGS (Operating temperature range applies unless otherwise specified)

Parameter	Symbol	Value	Unit
Input Voltage	V_i	35	V
Operating Junction Temperature Range	T_{OPR}	0-+125	$^\circ\text{C}$
Storage Temperature Range	T_{STG}	-65-+150	$^\circ\text{C}$

ELECTRICAL CHARACTERISTICS ($V_i=23\text{V}, I_o=350\text{mA}, C_i=0.33\mu\text{F}, C_o=0.1\mu\text{F}$, unless otherwise specified)

Parameter	Symbol	Test conditions	Min	Typ	Max	Unit	
Output Voltage	V_o	$V_i=23\text{V}, I_o=350\text{mA}$	25 $^\circ\text{C}$	14.4	15	15.6	V
		$17.5\text{V} \leq V_i \leq 30\text{V}, I_o=5\text{mA} \sim 350\text{mA}$ $P_o \leq 15\text{W}$	0-125 $^\circ\text{C}$	14.25	15	15.75	V
Load Regulation	ΔV_o	$I_o=5\text{mA} \sim 500\text{mA}$	25 $^\circ\text{C}$			300	mV
		$I_o=5\text{mA} \sim 200\text{mA}$	25 $^\circ\text{C}$			150	mV
Line Regulation	ΔV_o	$17.5\text{V} \leq V_i \leq 30\text{V}, I_o=200\text{mA}$	25 $^\circ\text{C}$			100	mV
		$20\text{V} \leq V_i \leq 26\text{V}, I_o=200\text{mA}$	25 $^\circ\text{C}$			50	mV
Quiescent Current	I_q	$V_i=23\text{V}, I_o=350\text{mA}$	25 $^\circ\text{C}$		6	mA	
Quiescent Current Change	ΔI_q	$17.5\text{V} \leq V_i \leq 30\text{V}, I_o=200\text{mA}$	0-125 $^\circ\text{C}$			0.8	mA
	ΔI_q	$V_i=23\text{V}, I_o=5\text{mA} \sim 350\text{mA}$	0-125 $^\circ\text{C}$			0.5	mA
Output Noise Voltage	V_N	10Hz $\leq f \leq$ 100KHz	25 $^\circ\text{C}$		90	μV	
Ripple Rejection	RR	$18.5\text{V} \leq V_i \leq 28.5\text{V}, f=120\text{Hz}, I_o=300\text{mA}$	0-125 $^\circ\text{C}$	54		dB	
Dropout Voltage	V_d		25 $^\circ\text{C}$		2	V	

TYPICAL APPLICATION

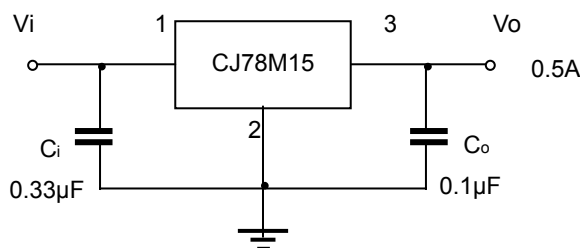

Typical Characteristics

Output Characteristics

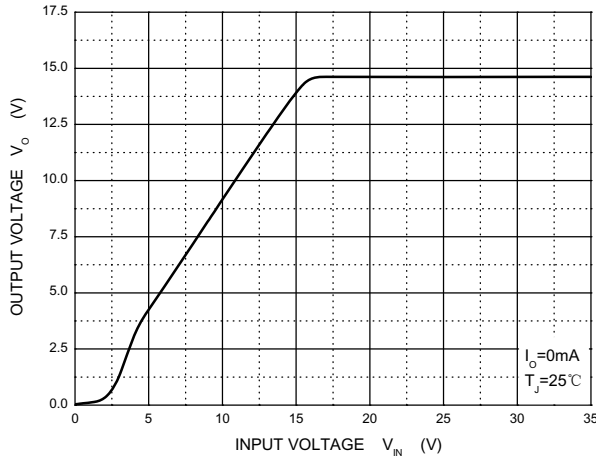

Dropout Characteristics

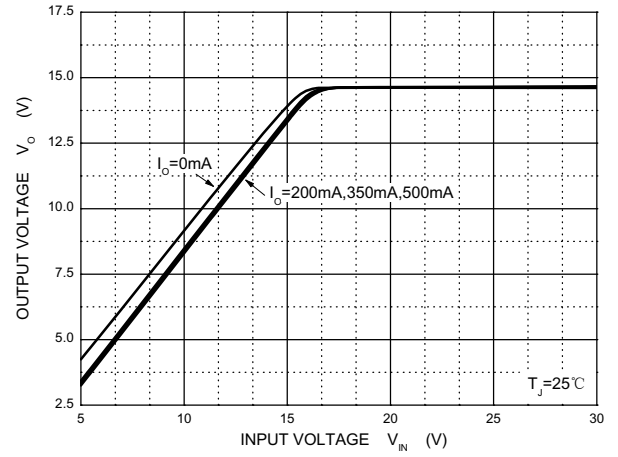

Quiescent Current vs Input Voltage

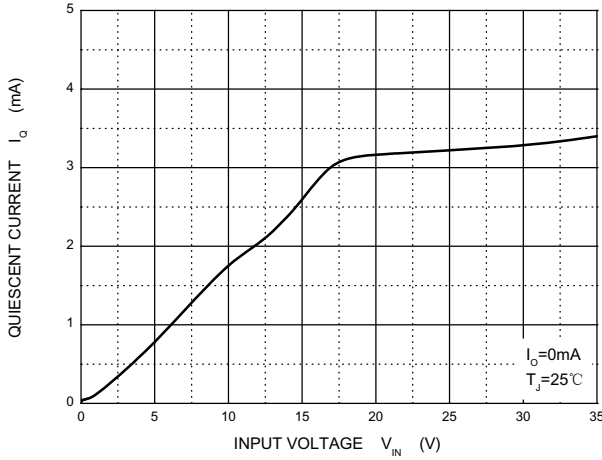

Quiescent Current vs Output Current

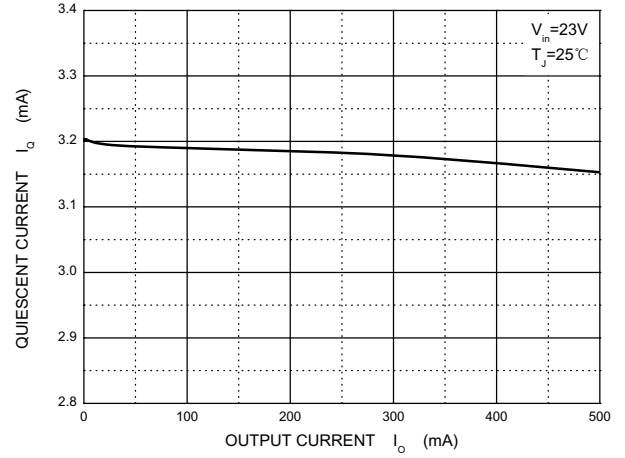

Output Voltage vs Ambient Temperature

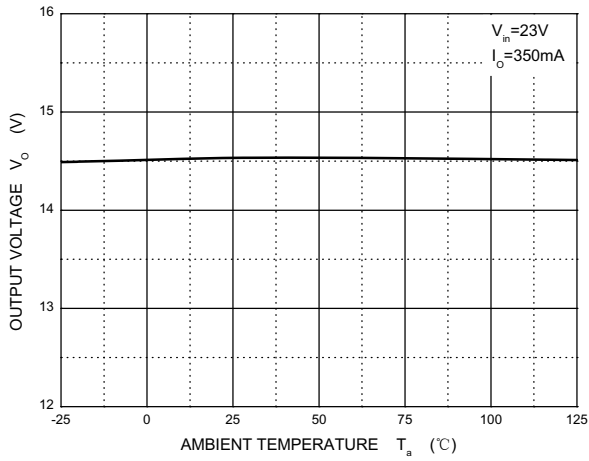

Current Cut-off Grid Voltage

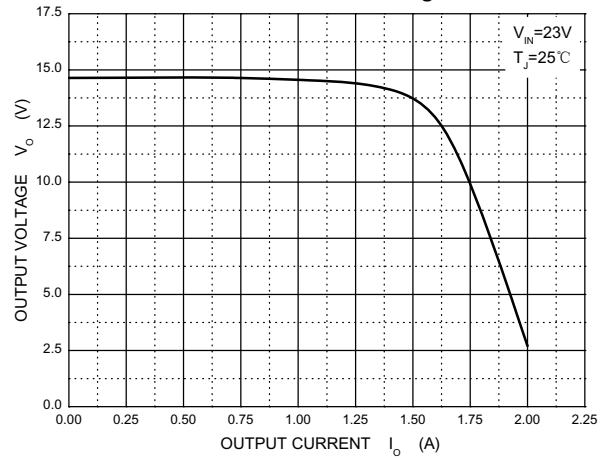

Power Derating Curve

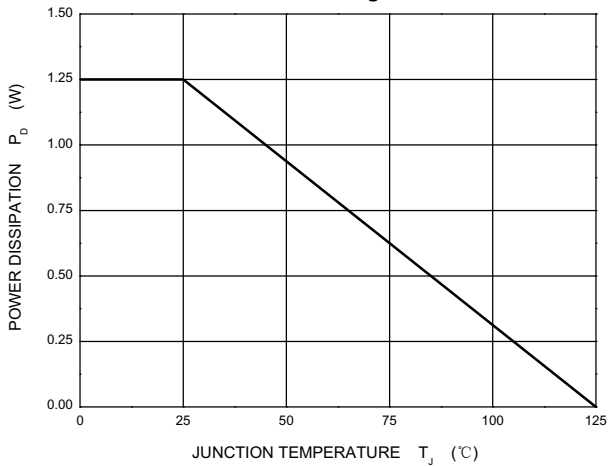

TO-252(4R)-2L Package Outline Dimensions

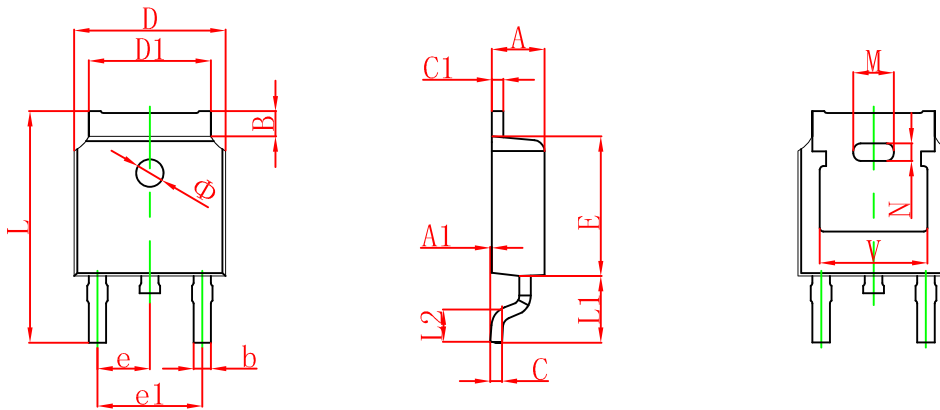

Symbol	Dimensions In Millimeters		Dimensions In Inches	
	Min.	Max.	Min.	Max.
A	2.200	2.380	0.087	0.094
A1	0.000	0.100	0.000	0.004
B	0.800	1.400	0.031	0.055
b	0.710	0.810	0.028	0.032
c	0.460	0.560	0.018	0.022
c1	0.460	0.560	0.018	0.022
D	6.500	6.700	0.256	0.264
D1	5.130	5.460	0.202	0.215
E	6.000	6.200	0.236	0.244
e	2.286 TYP.		0.090 TYP.	
e1	4.327	4.727	0.170	0.186
M	1.778REF.		0.070REF.	
N	0.762REF.		0.018REF.	
L	9.800	10.400	0.386	0.409
L1	2.9REF.		0.114REF.	
L2	1.400	1.700	0.055	0.067
V	4.830 REF.		0.190 REF.	
Φ	1.100	1.300	0.043	0.051

TO-252(4R)-2L Suggested Pad Layout

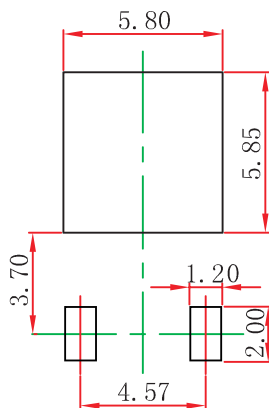

Note:

1. Controlling dimension: in millimeters.
2. General tolerance: ± 0.05 mm.
3. The pad layout is for reference purposes only.

NOTICE

JCET reserve the right to make modifications, enhancements, improvements, corrections or other changes without further notice to any product herein. JCET does not assume any liability arising out of the application or use of any product described herein.

TO-252 Tape and reel

TO-252 Embossed Carrier Tape

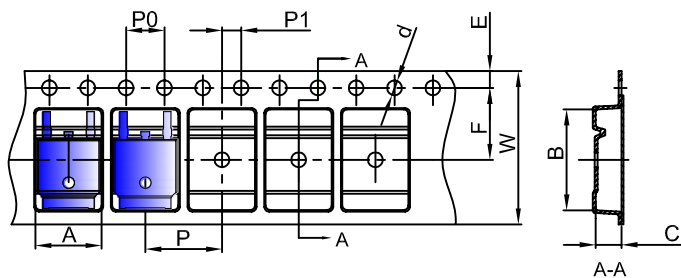

Packaging Description:

TO-252 parts are shipped in tape. The carrier tape is made from a dissipative (carbon filled) polycarbonate resin. The cover tape is a multilayer film (Heat Activated Adhesive in nature) primarily composed of polyester film, adhesive layer, sealant, and anti-static sprayed agent. These reeled parts in standard option are shipped with 25,00 units per 13" or 33.0 cm diameter reel. The reels are clear in color and is made of polystyrene plastic (anti-static coated).

Dimensions are in millimeter										
Pkg type	A	B	C	d	E	F	P0	P	P1	W
TO-252	6.90	10.50	2.70	Ø1.55	1.75	7.50	4.00	8.00	2.00	16.00
(Tolerance)	+/-0.1	+/-0.1	+/-0.1	+/-0.1	+/-0.1	+/-0.1	+/-0.1	+/-0.1	+/-0.1	+0.3/-0.1

TO-252 Tape Leader and Trailer

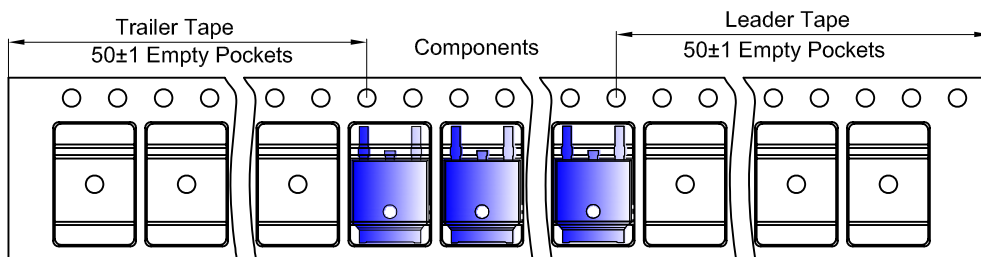

TO-252 Reel

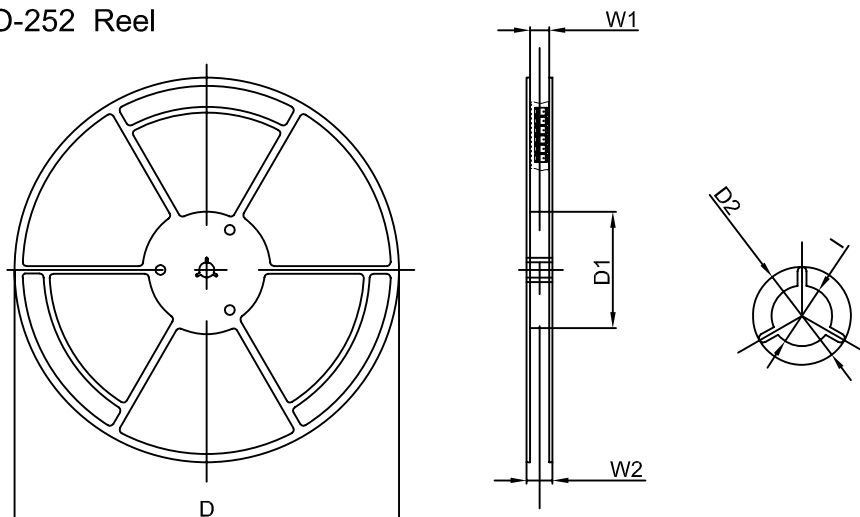

Dimensions are in millimeter						
Reel Option	D	D1	D2	W1	W2	I
13" Dia	330.00	100.00	Ø21.00	16.40	21.00	Ø13.00
Tolerance	+/-2	+/-1	+/-1	+/-1	+/-1	+/-1

REEL	Reel Size	Box	Box Size(mm)	Carton	Carton Size(mm)	G.W.(kg)
2,500 pcs	13inch	2,500 pcs	340×336×29	25,000 pcs	353×346×365	14.04