

N-Channel Enhancement Mode MOSFET

Features

- 120V/120A,
 $R_{DS(ON)} = 8.4m\Omega(max.) @ V_{GS} = 10V$
- Reliable and Rugged
- Lead Free and Green Devices Available
(RoHS Compliant)

Pin Description

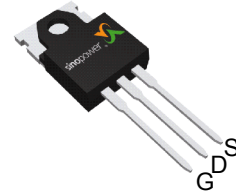

Top View of TO-220H

Applications

- Synchronous Rectification.
- Power Management in Inverter Systems.
- Motor Driver.

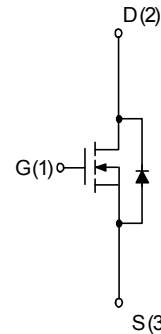

N-Channel MOSFET

Ordering and Marking Information

<p>SM1C01NS □□□-□□□</p> <div style="margin-left: 20px;"> <p>└─ Assembly Material</p> <p>└─ Handling Code</p> <p>└─ Temperature Range</p> <p>└─ Package Code</p> </div>	<p>Package Code FH : TO-220H</p> <p>Operating Junction Temperature Range C : -55 to 175 °C</p> <p>Handling Code TU : Tube (50ea/tube)</p> <p>Assembly Material G : Halogen and Lead Free Device</p>
<p>SM1C01NS FH :</p> <div style="border: 1px solid black; padding: 2px; display: inline-block; margin-left: 10px;">  <p>SM1C01N XXXXX</p> </div>	<p>XXXXX - Lot Code</p>

Note : SINOPOWER lead-free products contain molding compounds/die attach materials and 100% matte tin plate termination finish; which are fully compliant with RoHS. SINOPOWER lead-free products meet or exceed the lead-free requirements of IPC/JEDEC J-STD-020D for MSL classification at lead-free peak reflow temperature. SINOPOWER defines "Green" to mean lead-free (RoHS compliant) and halogen free (Br or Cl does not exceed 900ppm by weight in homogeneous material and total of Br and Cl does not exceed 1500ppm by weight).

SINOPOWER reserves the right to make changes to improve reliability or manufacturability without notice, and advise customers to obtain the latest version of relevant information to verify before placing orders.

Absolute Maximum Ratings ($T_A = 25^\circ\text{C}$ Unless Otherwise Noted)

Symbol	Parameter	Rating	Unit
Common Ratings			
V_{DSS}	Drain-Source Voltage	120	V
V_{GSS}	Gate-Source Voltage	± 25	
T_J	Maximum Junction Temperature	150	$^\circ\text{C}$
T_{STG}	Storage Temperature Range	-55 to 150	
I_S	Diode Continuous Forward Current	$T_C=25^\circ\text{C}$ 80	A
I_D	Continuous Drain Current	$T_C=25^\circ\text{C}$ 120	
I_{DM}	Pulsed Drain Current	$T_C=25^\circ\text{C}$ 400 ^a	
P_D	Maximum Power Dissipation	$T_C=25^\circ\text{C}$ 250	W
		$T_C=100^\circ\text{C}$ 100	
$R_{\theta JC}$	Thermal Resistance-Junction to Case	Steady State 0.5	$^\circ\text{C/W}$
I_D	Continuous Drain Current	$T_A=25^\circ\text{C}$ 11	A
		$T_A=70^\circ\text{C}$ 9	
P_D	Maximum Power Dissipation	$T_A=25^\circ\text{C}$ 2	W
		$T_A=70^\circ\text{C}$ 1.25	
$R_{\theta JA}$	Thermal Resistance-Junction to Ambient	Steady State 62.5	$^\circ\text{C/W}$
I_{AS}^b	Avalanche Current, Single pulse	$L=0.5\text{mH}$ 45	A
E_{AS}^b	Avalanche Energy, Single pulse	$L=0.5\text{mH}$ 500	mJ

Note a : Pulse width limited by max. junction temperature.

Note b : UIS tested and pulse width limited by maximum junction temperature 150°C (initial temperature $T_J=25^\circ\text{C}$).

Electrical Characteristics (T_A = 25°C Unless Otherwise Noted)

Symbol	Parameter	Test Conditions	Min.	Typ.	Max.	Unit
Static Characteristics						
BV _{DSS}	Drain-Source Breakdown Voltage	V _{GS} =0V, I _{DS} =250μA	120	-	-	V
I _{DSS}	Zero Gate Voltage Drain Current	V _{DS} =96V, V _{GS} =0V T _J =85°C	-	-	1	μA
			-	-	30	
V _{GS(th)}	Gate Threshold Voltage	V _{DS} =V _{GS} , I _{DS} =250μA	2	3	4	V
I _{GSS}	Gate Leakage Current	V _{GS} =±25V, V _{DS} =0V	-	-	±100	nA
R _{DS(ON)} ^c	Drain-Source On-state Resistance	V _{GS} =10V, I _{DS} =40A	-	7	8.4	mΩ
Diode Characteristics						
V _{SD} ^c	Diode Forward Voltage	I _{SD} =20A, V _{GS} =0V	-	0.8	1.3	V
t _{rr}	Reverse Recovery Time	I _{SD} =40A, di _{SD} /dt=100A/μs	-	56	-	ns
Q _{rr}	Reverse Recovery Charge		-	140	-	nC
Dynamic Characteristics^d						
R _G	Gate Resistance	V _{GS} =0V, V _{DS} =0V, f=1MHz	-	1.0	-	Ω
C _{iss}	Input Capacitance	V _{GS} =0V, V _{DS} =30V, Frequency=1.0MHz	-	6150	8000	pF
C _{oss}	Output Capacitance		-	625	-	
C _{rss}	Reverse Transfer Capacitance		-	120	-	
t _{d(ON)}	Turn-on Delay Time	V _{DD} =30V, R _L =30Ω, I _{DS} =1A, V _{GEN} =10V, R _G =6Ω	-	26	47	ns
t _r	Turn-on Rise Time		-	10	18	
t _{d(OFF)}	Turn-off Delay Time		-	92	166	
t _f	Turn-off Fall Time		-	55	99	
Gate Charge Characteristics^d						
Q _g	Total Gate Charge	V _{DS} =30V, V _{GS} =10V, I _{DS} =40A	-	100	140	nC
Q _{gs}	Gate-Source Charge		-	29	-	
Q _{gd}	Gate-Drain Charge		-	19	-	

Note c : Pulse test ; pulse width ≤ 300μs, duty cycle ≤ 2%.

Note d : Guaranteed by design, not subject to production testing.

Typical Operating Characteristics

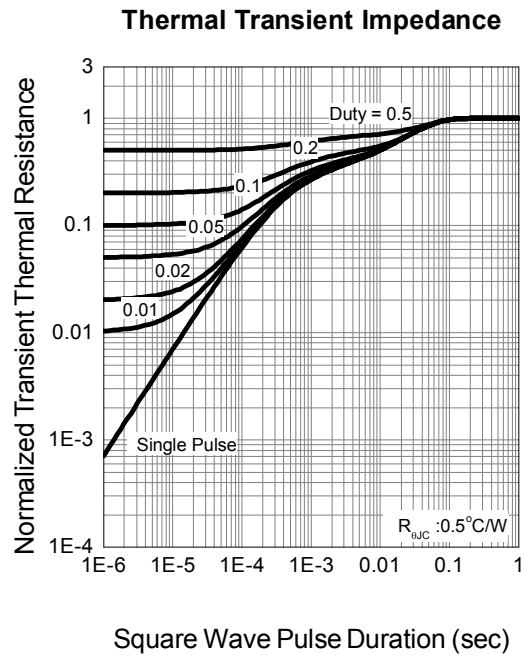
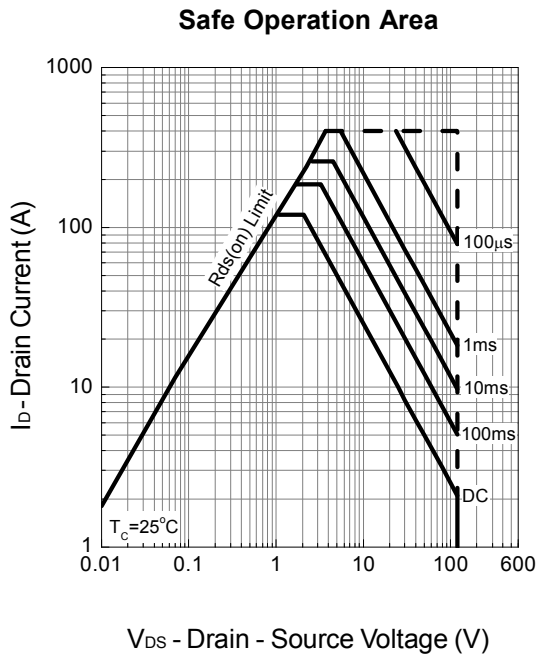
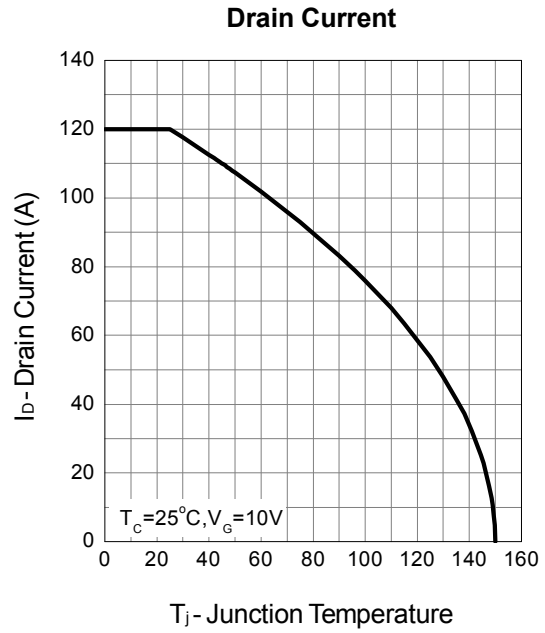
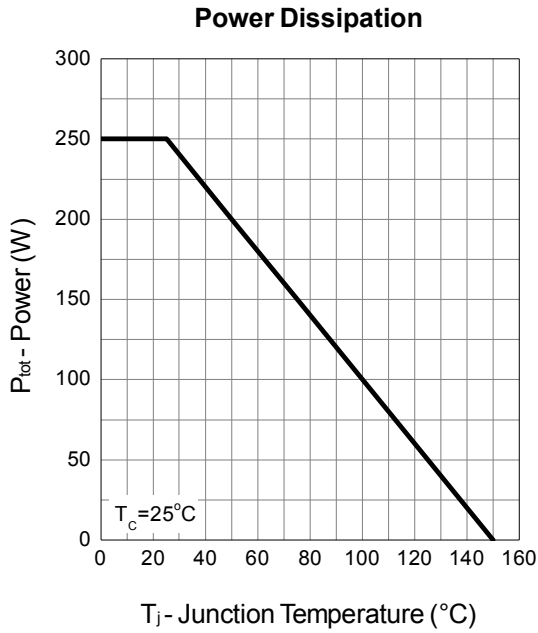

Typical Operating Characteristics (Cont.)

Output Characteristics

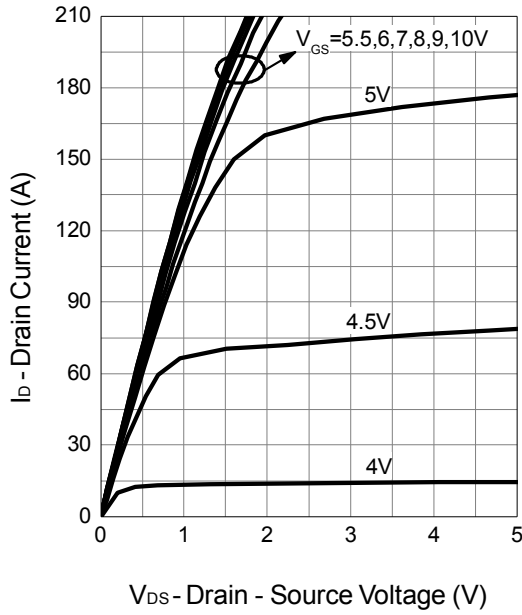

Drain-Source On Resistance

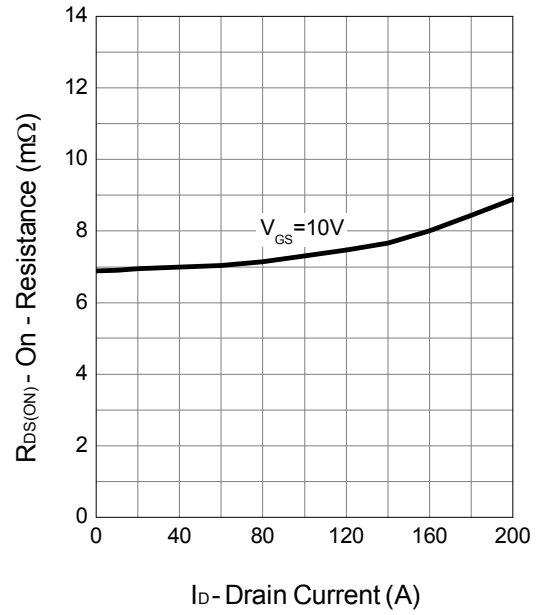

Gate-Source On Resistance

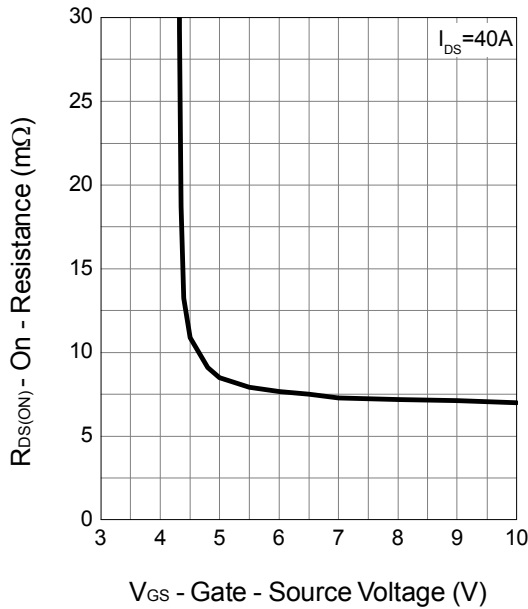

Gate Threshold Voltage

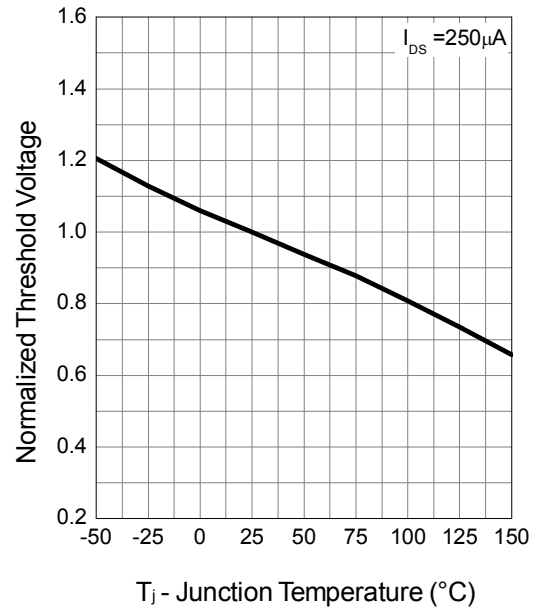

Typical Operating Characteristics (Cont.)

Drain-Source On Resistance

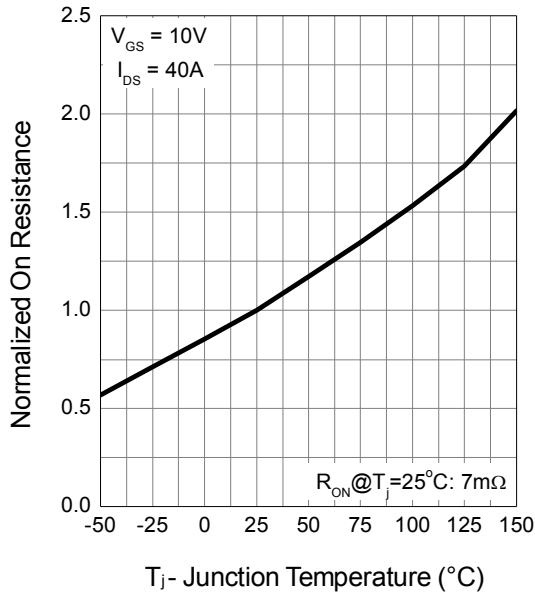

Source-Drain Diode Forward

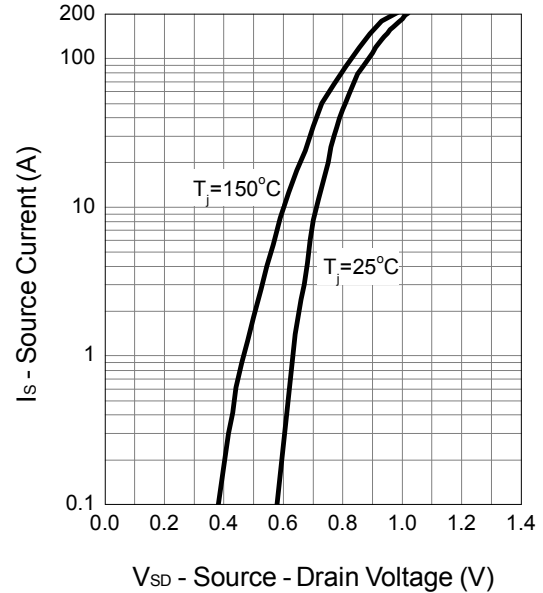

Capacitance

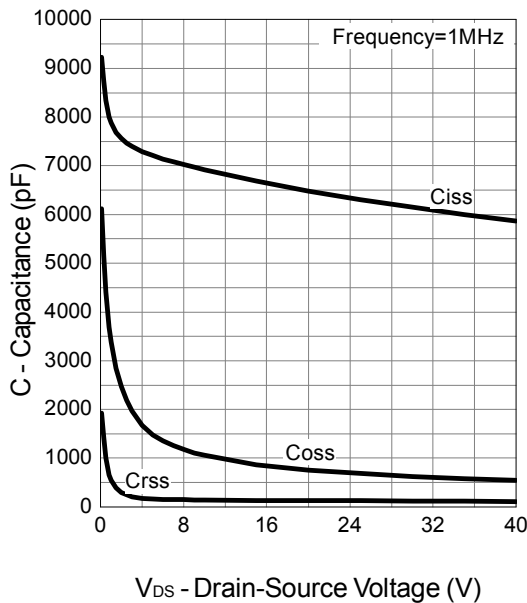

Gate Charge

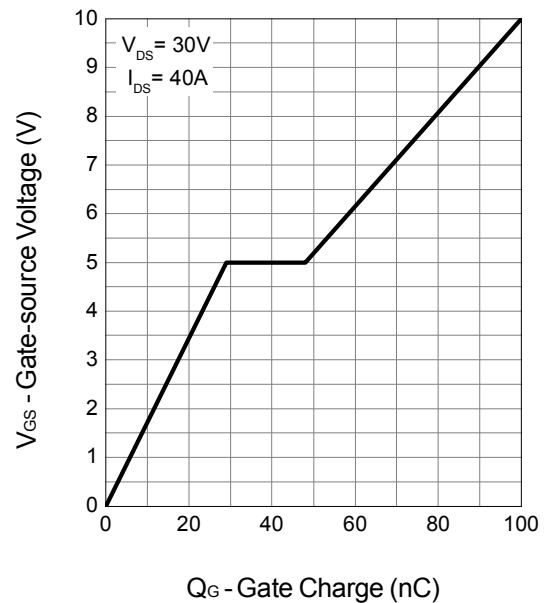

Avalanche Test Circuit and Waveforms

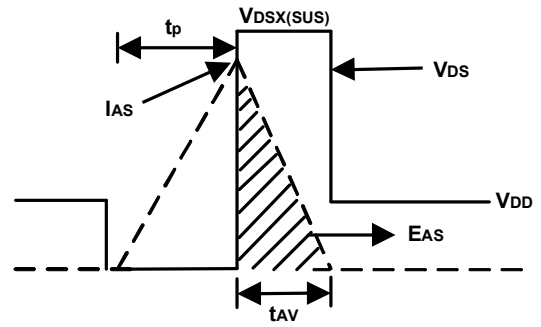
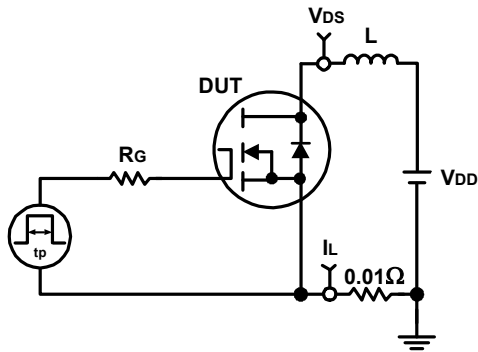

Switching Time Test Circuit and Waveforms

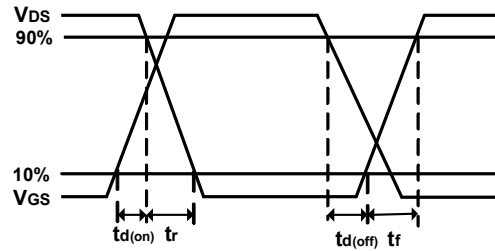
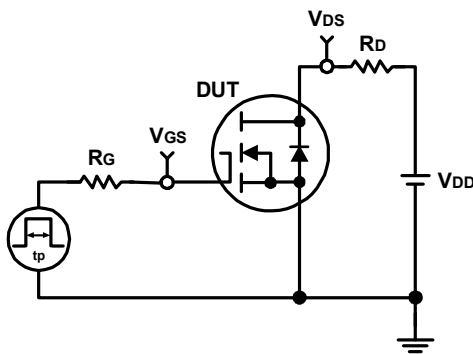

Package Information

TO-220H

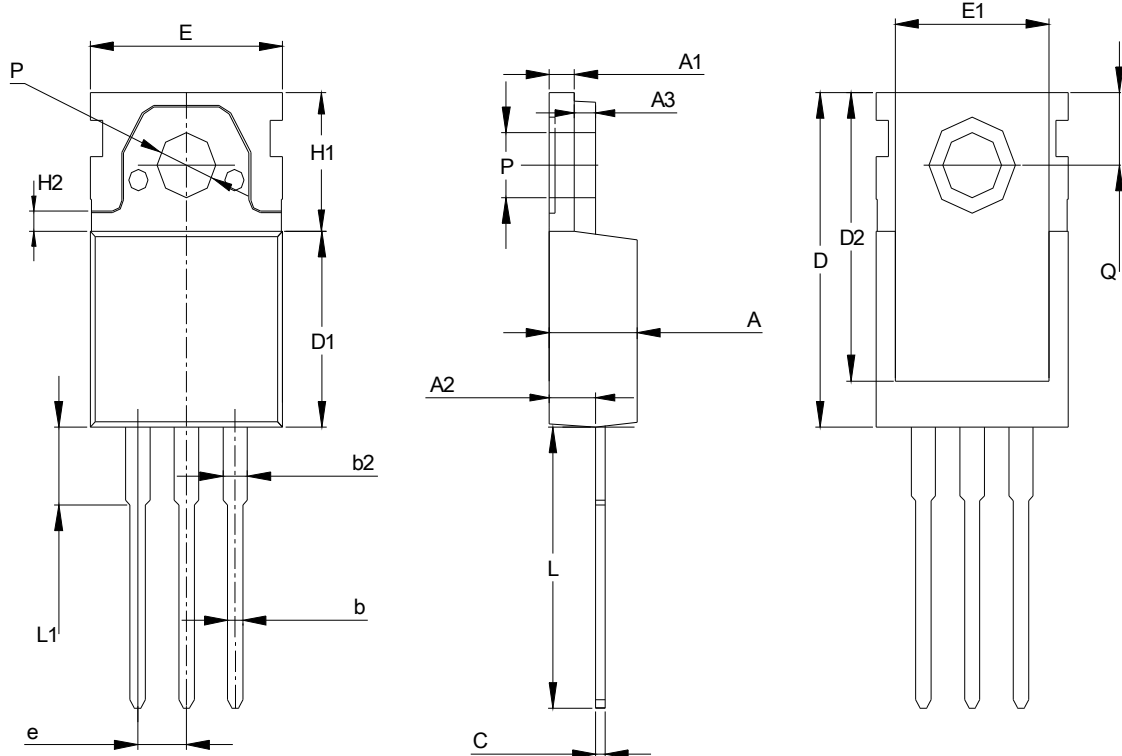

SYMBOL	TO-220H			
	MILLIMETERS		INCHES	
	MIN.	MAX.	MIN.	MAX.
A	3.56	4.83	0.140	0.190
A1	0.51	1.50	0.020	0.059
A2	2.03	2.92	0.080	0.115
A3	1.05	1.15	0.041	0.045
b	0.38	1.02	0.015	0.040
b2	1.14	1.78	0.045	0.070
c	0.36	0.61	0.014	0.024
D	14.22	16.51	0.560	0.650
D1	8.38	9.30	0.330	0.366
D2	12.19	13.65	0.480	0.537
E	9.65	10.67	0.380	0.420
E1	6.86	8.89	0.270	0.350
e	2.54 BSC		0.100 BSC	
H1	5.84	6.86	0.230	0.270
H2	0.95	1.05	0.037	0.041
L	12.70	14.73	0.500	0.580
L1	-	6.35	-	0.250
P	3.00	3.20	0.118	0.126
Q	3.30	3.50	0.130	0.138

RECOMMENDED LAND PATTERN

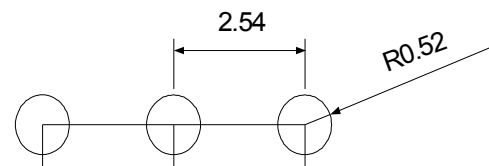

UNIT: mm

Classification Profile

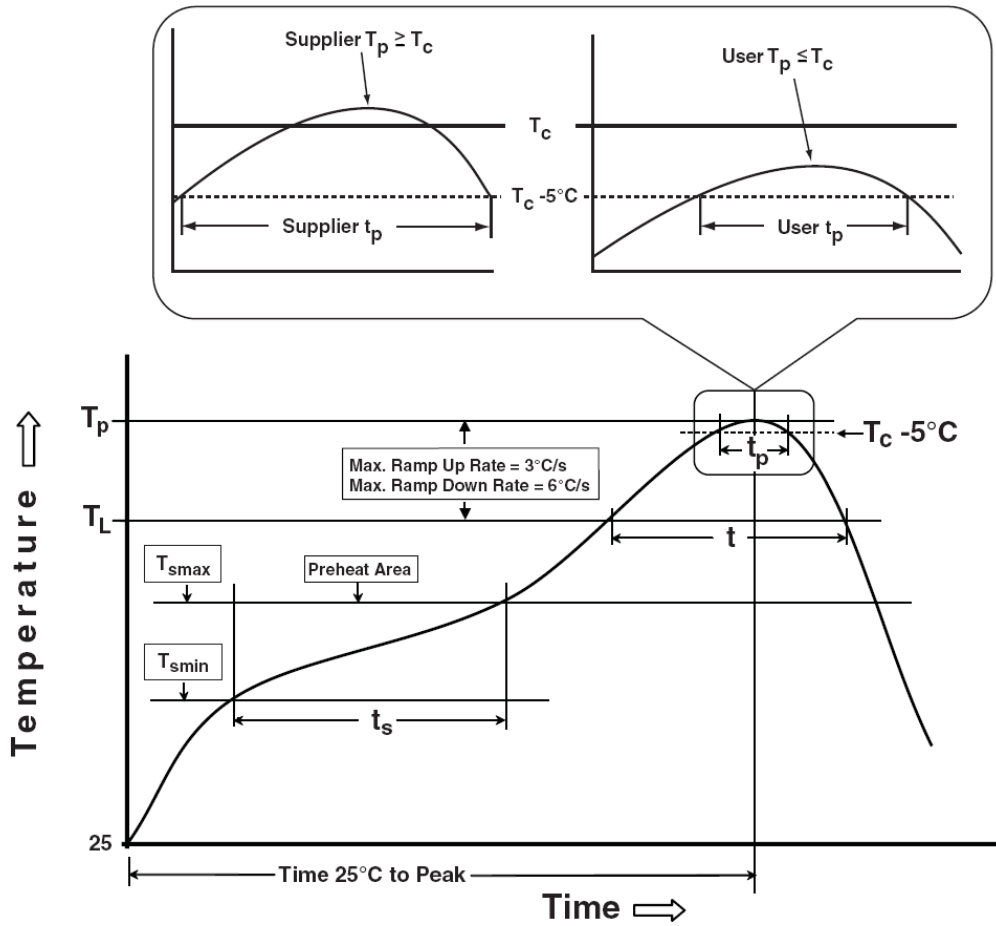

Classification Reflow Profiles

Profile Feature	Sn-Pb Eutectic Assembly	Pb-Free Assembly
Preheat & Soak		
Temperature min (T_{smin})	100 °C	150 °C
Temperature max (T_{smax})	150 °C	200 °C
Time (T_{smin} to T_{smax}) (t_s)	60-120 seconds	60-120 seconds
Average ramp-up rate (T_{smax} to T_p)	3 °C/second max.	3°C/second max.
Liquidous temperature (T_L)	183 °C	217 °C
Time at liquidous (t_L)	60-150 seconds	60-150 seconds
Peak package body Temperature (T_p)*	See Classification Temp in table 1	See Classification Temp in table 2
Time (t_p)** within 5°C of the specified classification temperature (T_c)	20** seconds	30** seconds
Average ramp-down rate (T_p to T_{smax})	6 °C/second max.	6 °C/second max.
Time 25°C to peak temperature	6 minutes max.	8 minutes max.
* Tolerance for peak profile Temperature (T_p) is defined as a supplier minimum and a user maximum. ** Tolerance for time at peak profile temperature (t_p) is defined as a supplier minimum and a user maximum.		

Table 1. SnPb Eutectic Process – Classification Temperatures (T_c)

Package Thickness	Volume mm ³ <350	Volume mm ³ ≥350
<2.5 mm	235 °C	220 °C
≥2.5 mm	220 °C	220 °C

Table 2. Pb-free Process – Classification Temperatures (T_c)

Package Thickness	Volume mm ³ <350	Volume mm ³ 350-2000	Volume mm ³ >2000
<1.6 mm	260 °C	260 °C	260 °C
1.6 mm – 2.5 mm	260 °C	250 °C	245 °C
≥2.5 mm	250 °C	245 °C	245 °C

Reliability Test Program

Test item	Method	Description
SOLDERABILITY	JESD-22, B102	5 Sec, 245°C
HTRB	JESD-22, A108	1000 Hrs, 80% of VDS max @ T_{jmax}
HTGB	JESD-22, A108	1000 Hrs, 100% of VGS max @ T_{jmax}
PCT	JESD-22, A102	168 Hrs, 100%RH, 2atm, 121°C
TCT	JESD-22, A104	500 Cycles, -65°C~150°C

Customer Service

Sinopower Semiconductor, Inc.

5F, No. 6, Dusing 1St Rd., Hsinchu Science Park,

Hsinchu, 30078, Taiwan

TEL: 886-3-5635818 Fax: 886-3-5642050